

COE

Bringing together the users of Dassault Systèmes PLM solutions —
CATIA®, ENOVIA®, DELMIA®, SIMULIA® and 3DVia®

Merits Of Creating Morphable Powercopies for Sheet Metal Applications

*Brian Prasad, Parker
Hannifin/Parker Aerospace*

*Srinivasa Veerappa, HCL
America Inc*

*Allyn Van Ry, Parker
Hannifin/Parker Aerospace*

MAKING IT
WORK

COE 2012 ANNUAL PLM CONFERENCE & TECHNIFAIR
April 22-25 + Rio All-Suite Hotel & Casino + Las Vegas, NV

Application : Sheet-metal Power Copies (as Templates)

- Applications for sheet-metal are found across various industries such as aerospace, automobile etc., few example images are as shown below.
- Sheet-metal power-copies are very useful for creating a number of complex design configurations in a very short time.
- The first application is a family of computer cabinets. The second application is an PCB enclosure design.
- Due to proprietary nature of product and data, enclosure design application is not detailed whereas the computer cabinet application is discussed in full depth.

Aerospace



Construction



Auto trim parts

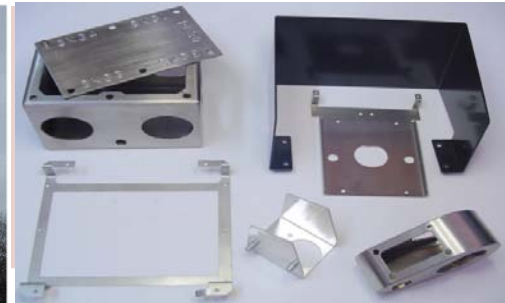

Review of Sheet Metal Applications

Two Examples

1. Computer Cabinets
2. Electronic Enclosures

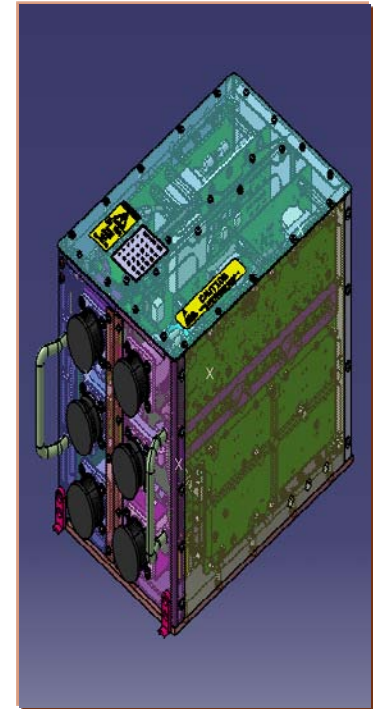

Review of Sheet Metal Applications

1. Computer Cabinets

Design Considerations

- Cabinet design based on contents: mother board form factor, S.M.P.S., hard drive bays, etc
- Different length/width/ height configurations need to be available to suit space requirements
- Sheet-metal cutouts for ventilation and mounting will vary from cabinet to cabinet
- Assembly and disassembly vary between cabinets
- Space must be left for future system upgrades



Review of Sheet Metal Applications (Contd)

2. Electronic Enclosures

Design Considerations

- Unique Designs based on available real state, operating clearances, minimum wall thickness, bend radii, etc.,
- Different configurations
- Design dependent on connectors, PCB plates , fixtures, cables, etc.
- New designs must be started from inside-out

Commonly starts from a base (hog-out) board, when a new request for an electronic enclosure arises.

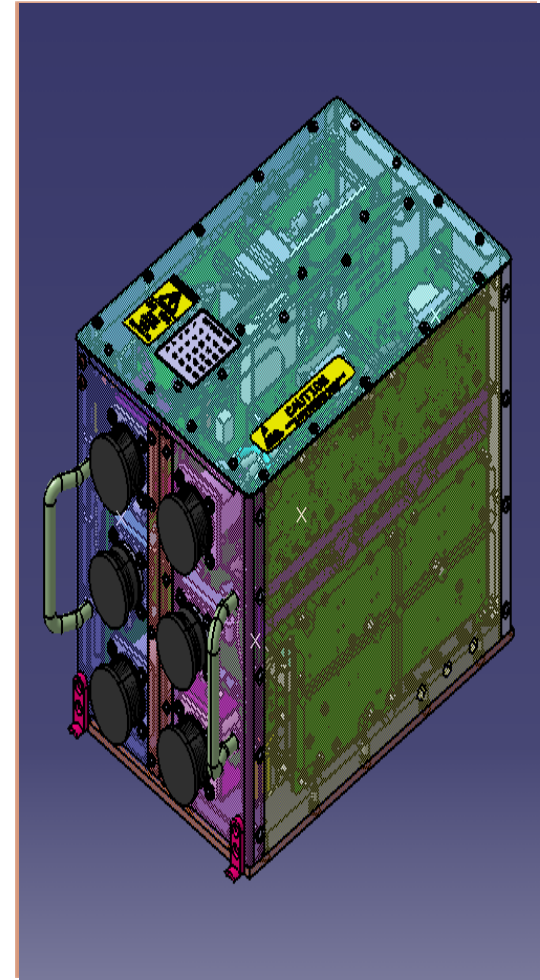

Design Challenges w/ Sheet Metal Parts

- Each Product involves 2-4 sheet-metal components, a PCB board, several cut outs for electronic components (connectors, power, battery pack, handle, fixtures, etc.)
- Need to accommodate a variety of product configurations within each product family
- For each configuration, need to consider
 - Variation in features, manufacturing processes
 - Variation in material selection, metal behavior & characteristics such as in sheet-metal corner relief, bend radius etc.,
 - Retooling, redesigning or maintaining the interface continuity across a network of sheet-metal templates.

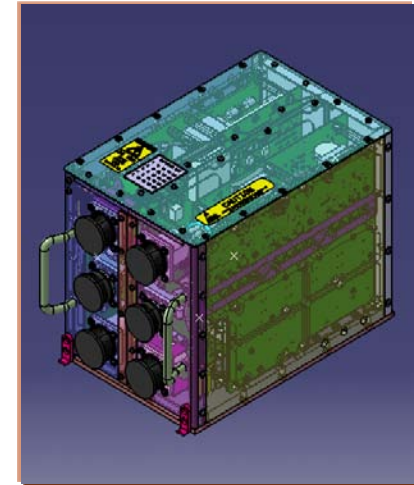

Issues w/ Convention (or traditional) design of sheet-metal parts

- The traditional design for the sheet-metal parts often uses CATIA Part design workbench.
- Thus, it consumes more time since the product development is a manual process.
- Sheet-metal features are generally dependent on one another.
- Removing or adding a feature on the tree might affect the tree structure or its geometrical outcome.
- The conventional design process cannot be standardized due to the interactive free-form design process.
 - This can create ambiguity amongst fellow design collaborators.
 - This makes it difficult to apply structured approach to capture design intent.

Proposed Solution: Build around Sheet Metal Templates

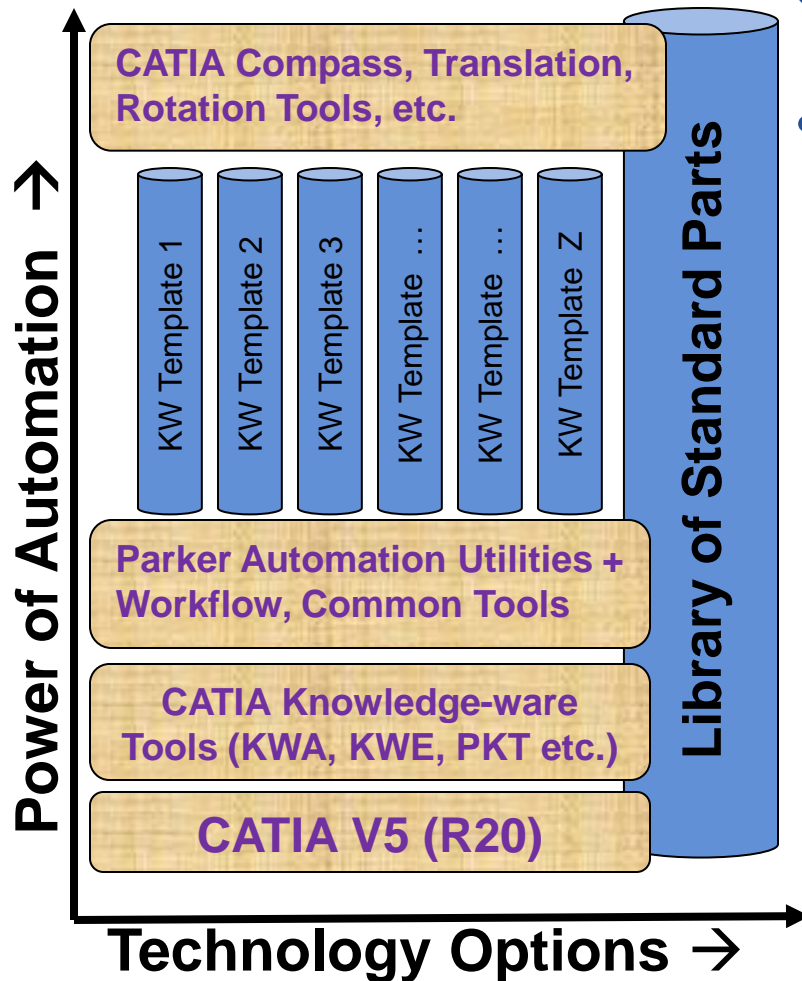

- Build a network of reusable (intelligent) templates
- Each KW templates may produce a particular product family representing one or more components of a large or complex system.
 - In this paper, we have used Power Copies (PCs) methodology as a way of building these templates.
 - Once a PC is developed, it provides a generalized template for producing a series of interconnected outputs of that product family.

Sheet-metal Templates (Contd)

- This set-up increases efficiency.
- A number of confirming products can be designed and developed much faster.
 - These templates utilize an existing library of standard parts in catalogs.
 - These templates capture the geometrical details into Ordered Geometrical Sets (OGS)
 - Synergy of KW Templates with Parker utilities are maintained
- Orderly collection of group of features provides immense flexibility in producing confirming product configurations with lower costs and risks.

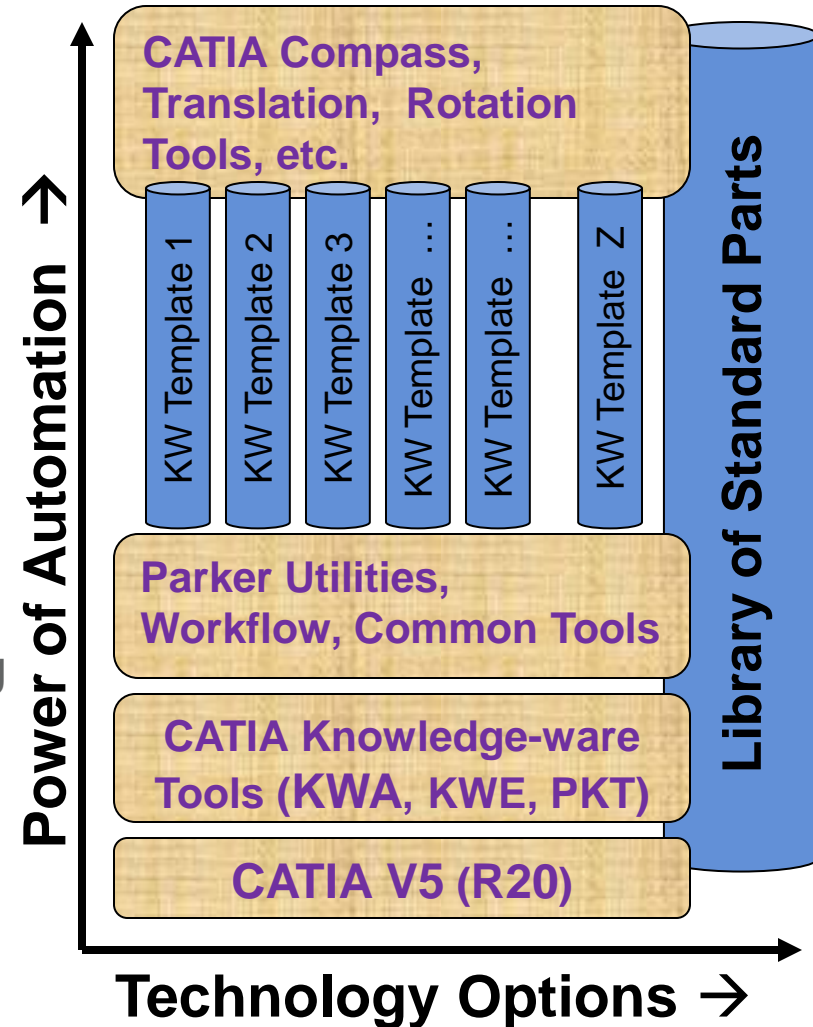

Elements Of an Intelligent Template (captured via Power-copy)

A typical power-copy generally consists of three primary construction elements:

- An Input geometry (this is captured into an OGS) and
- Part-Body geometry (this is also captured into another OGS).
- Output is the resultant geometry -- when a PC template is instantiated with specific inputs.

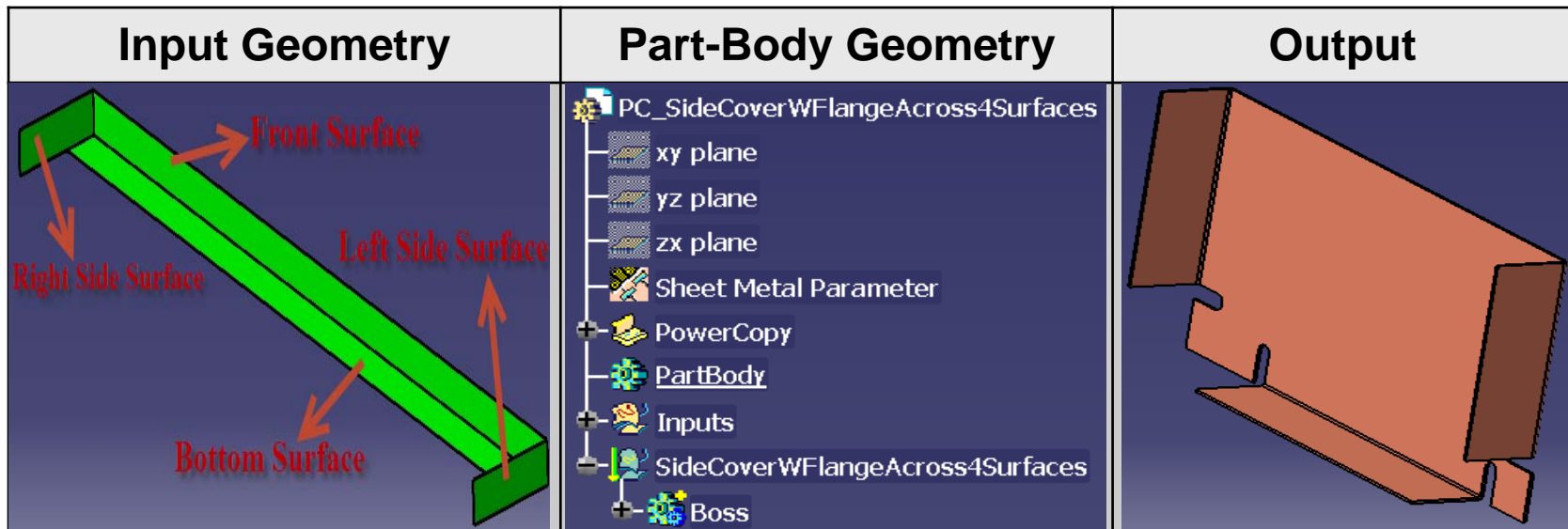

Elements Of an Intelligent Template (captured via Power-copy)

Input Geometry

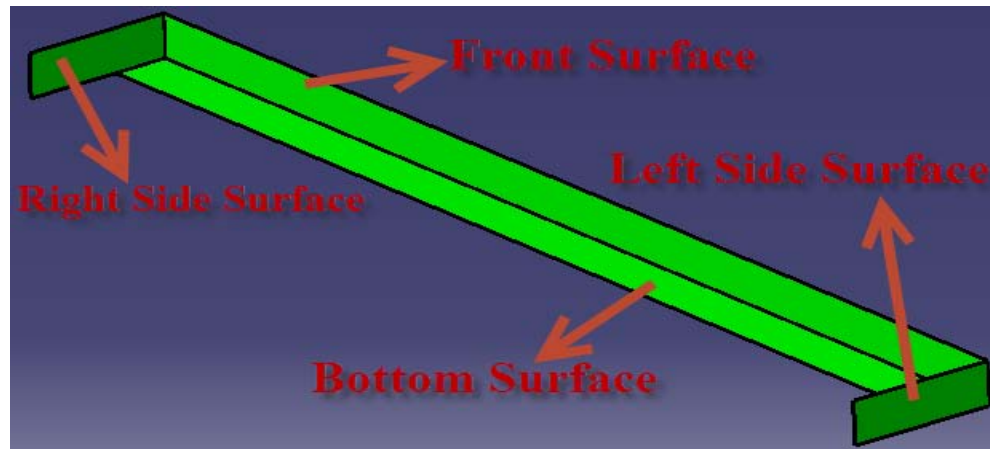

The inputs are required to position and orient the part accurately in the newly instantiated part. They provide the reference datum from which the topological variations can be achieved.

Elements Of an Intelligent Template (Power-copy) – Contd.

Part-Body geometry

- The geometrical set contains the construction geometry necessary for the creation of the cover part.
- It allows for the application of generative shape design elements, such as intersects etc., which can aid in positioning the part.

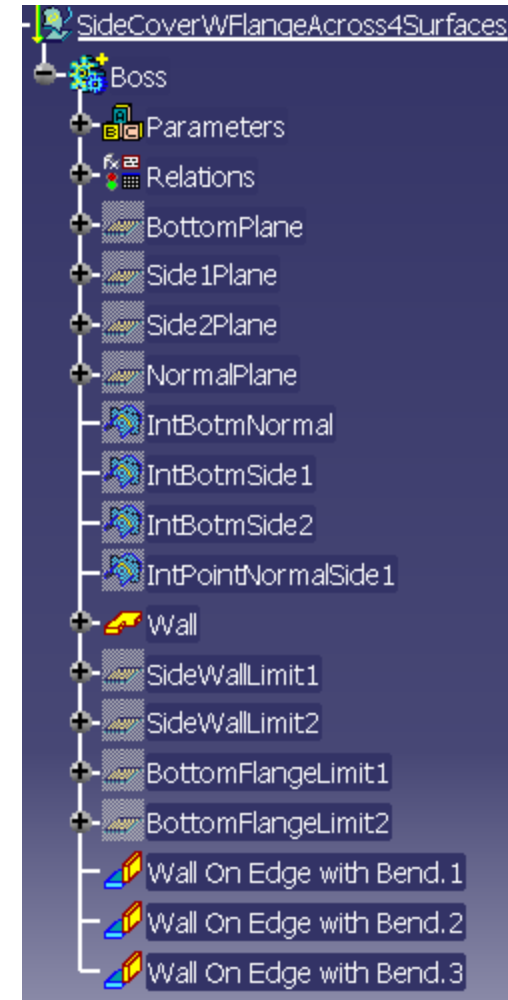

Elements Of an Intelligent Template (captured via Power-copy) Contd.

Output

The final stage is obtaining the required output.

This is the result of positioning sketches, sheet-metal features (bends), relief sketches, parameters and relation additions.

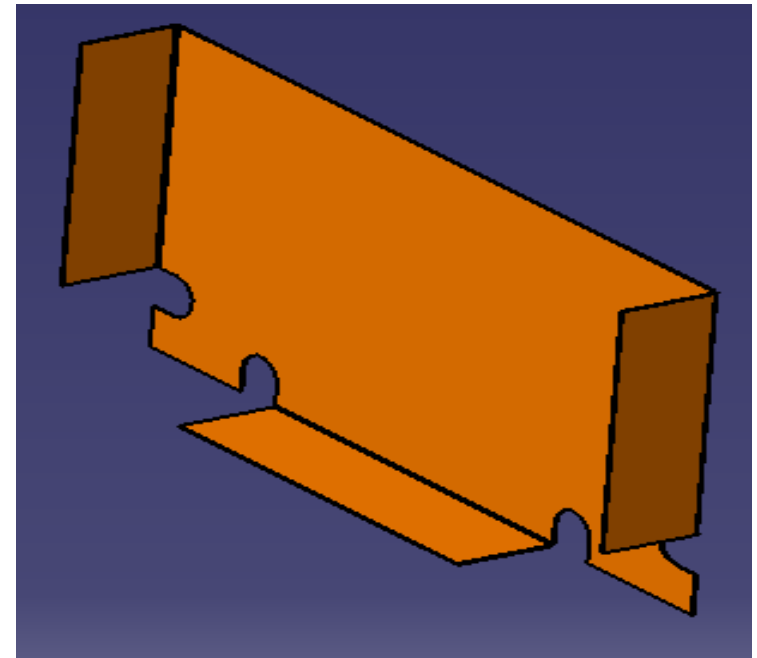

Features Of Power-copy

- Creation of confirming topological variations
- Flexibility and adaptability to get confirming designs for any specific valid users' inputs.
- Parameters and relations can be used to create and control a variety of features: corner reliefs, flange lengths, wall height, rules to turn walls (on/off), etc.

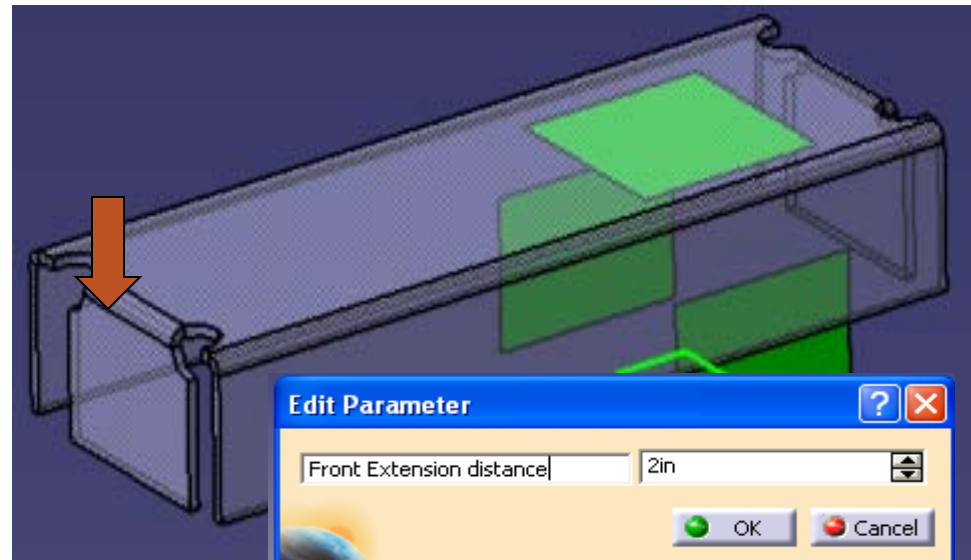
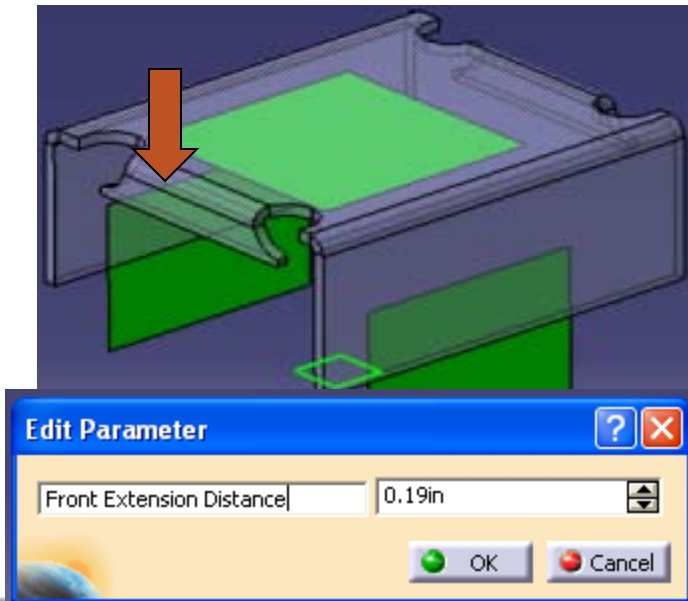

Features Of Power-copy Contd..

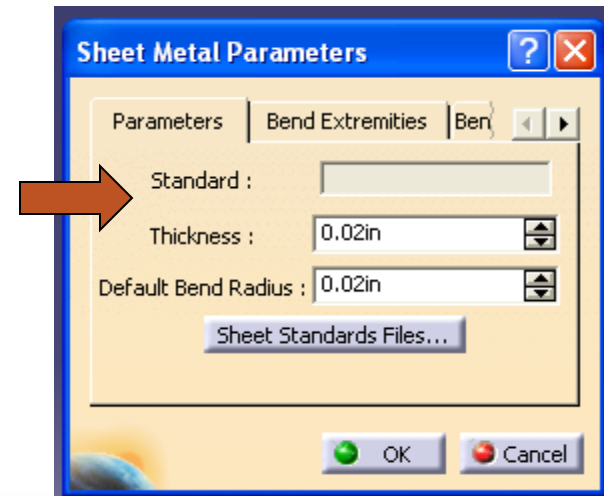
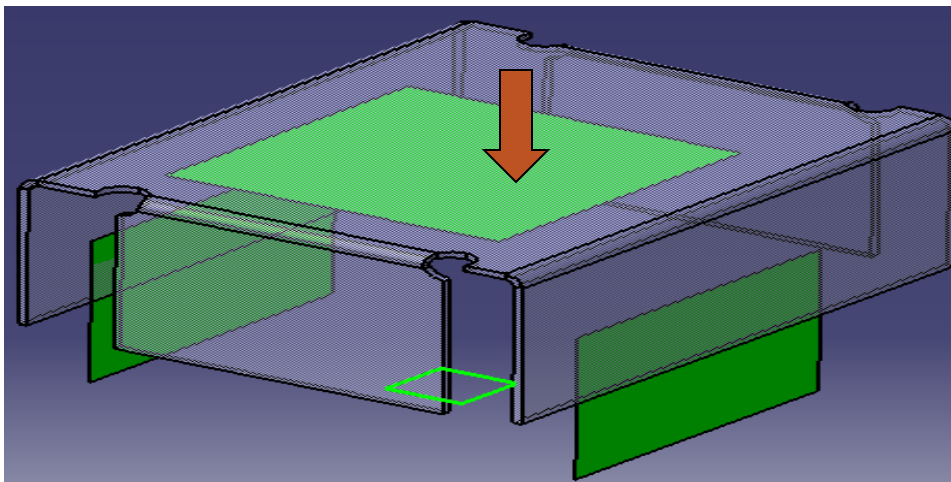
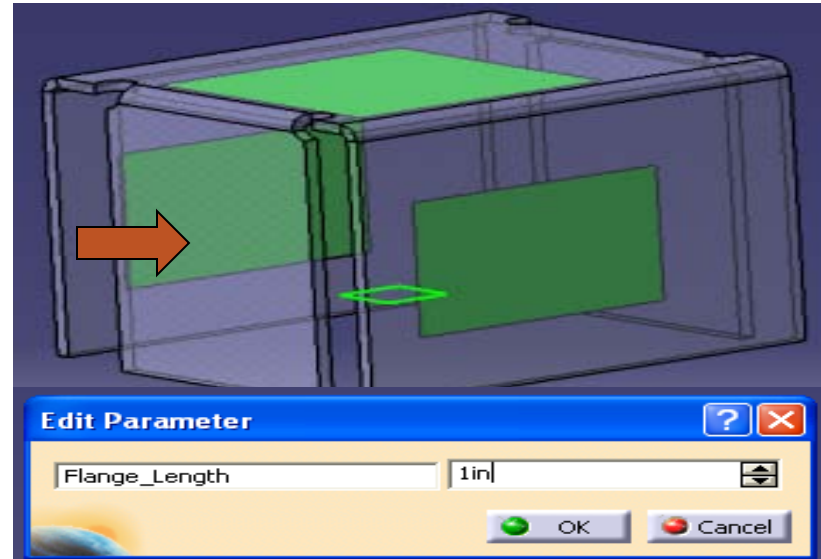
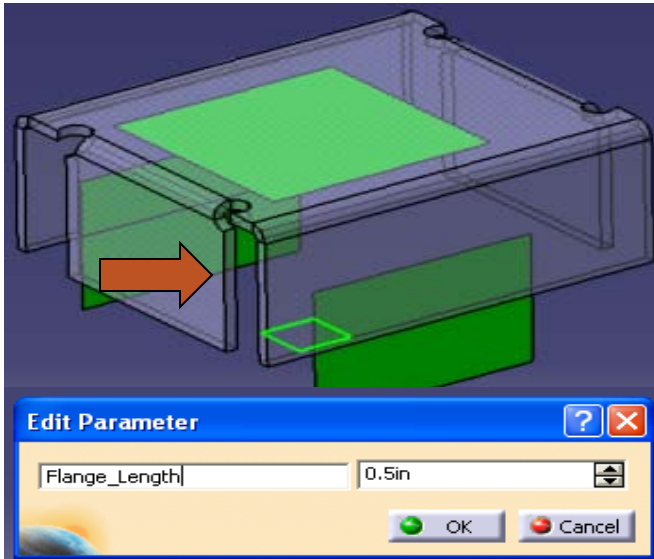

Features Of Power-copy Contd..

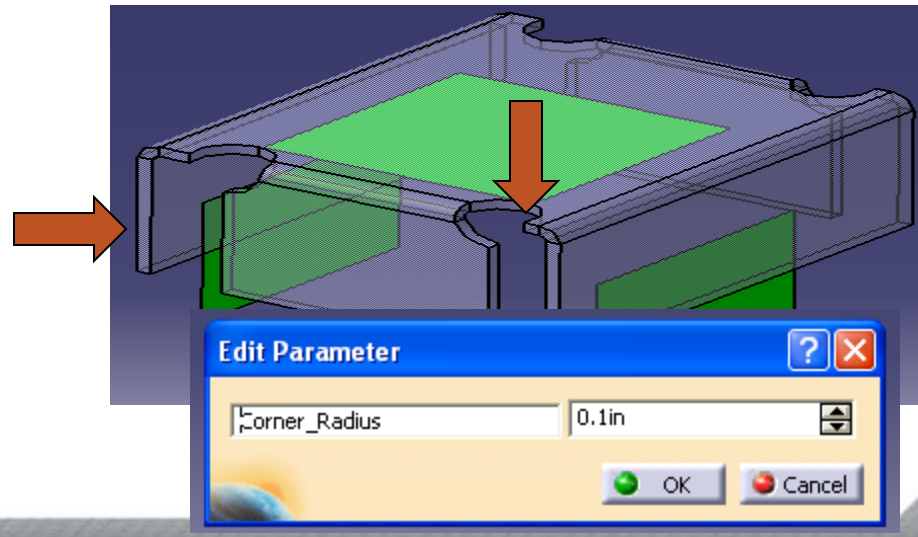
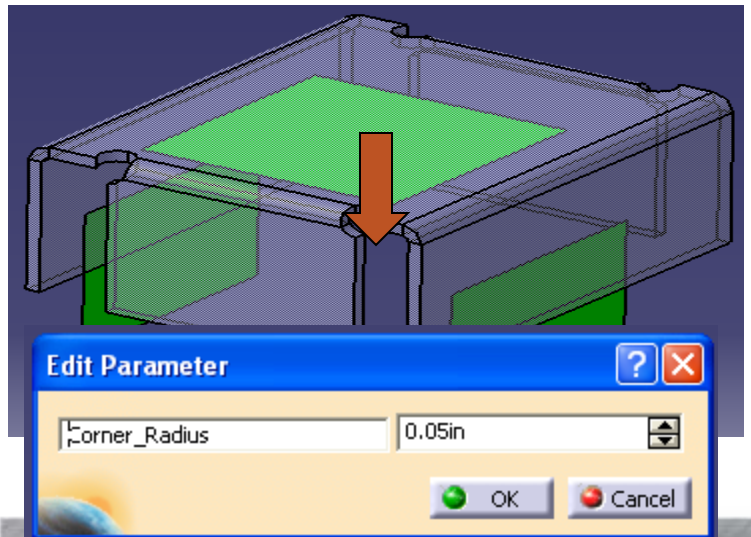
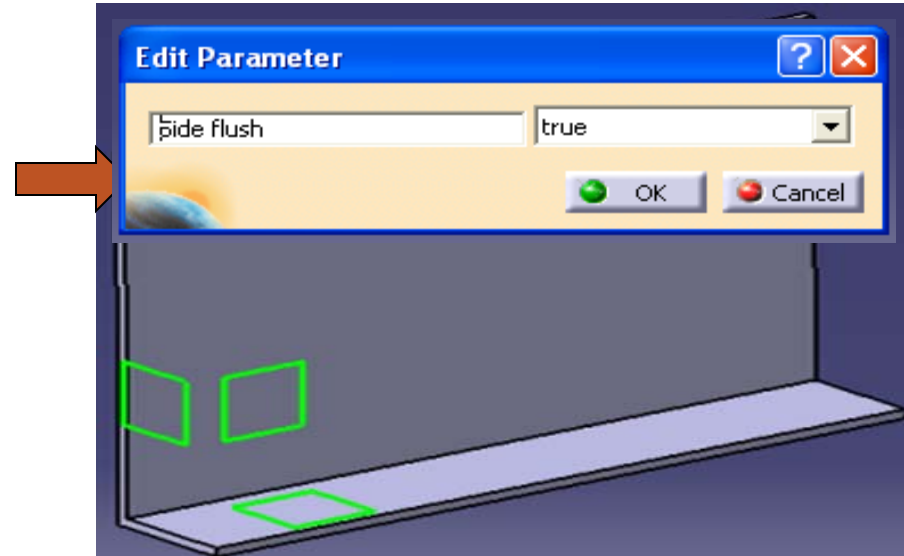
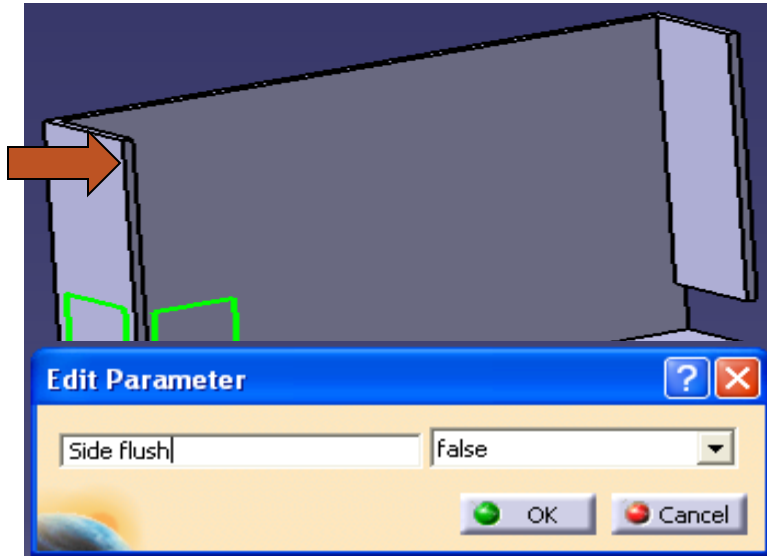

Features Of Power-copy Contd..

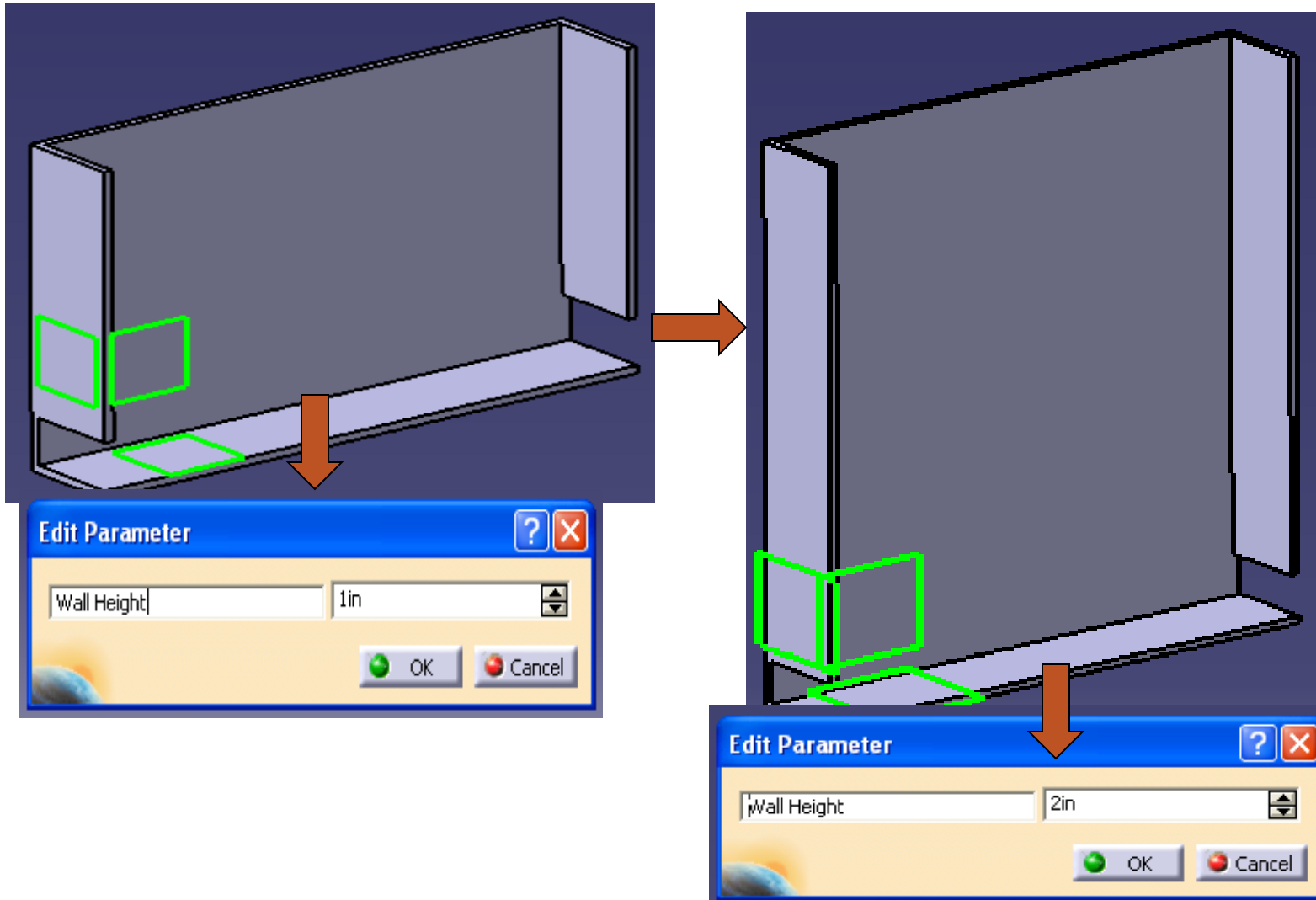

Different Configurations Of Cabinet (General)

Configuration-1

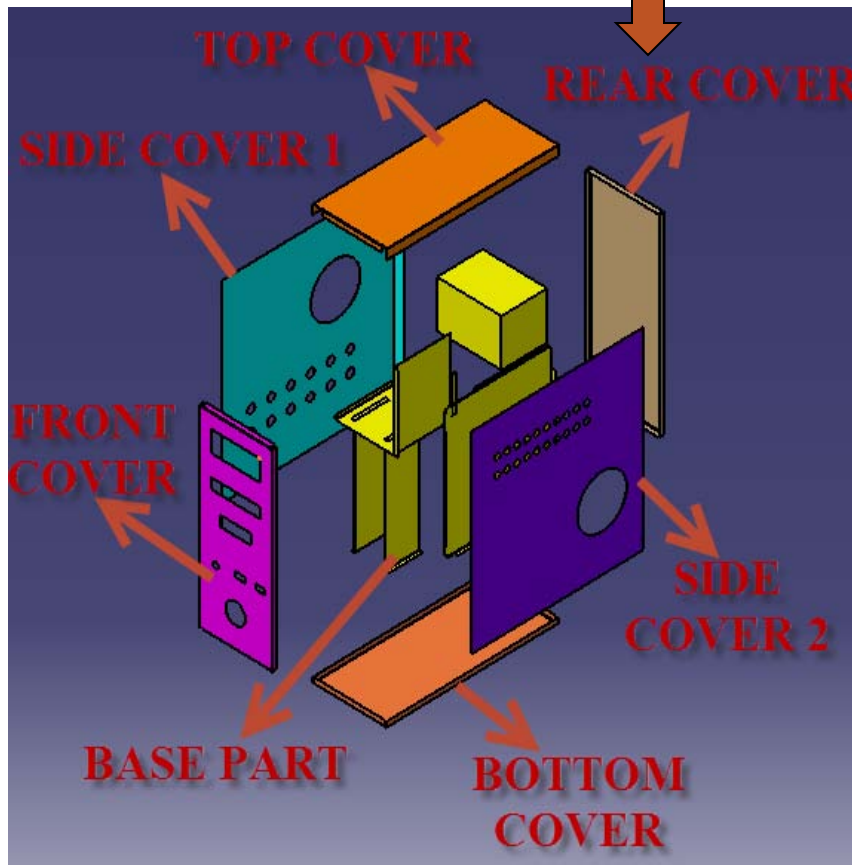

Configuration-2

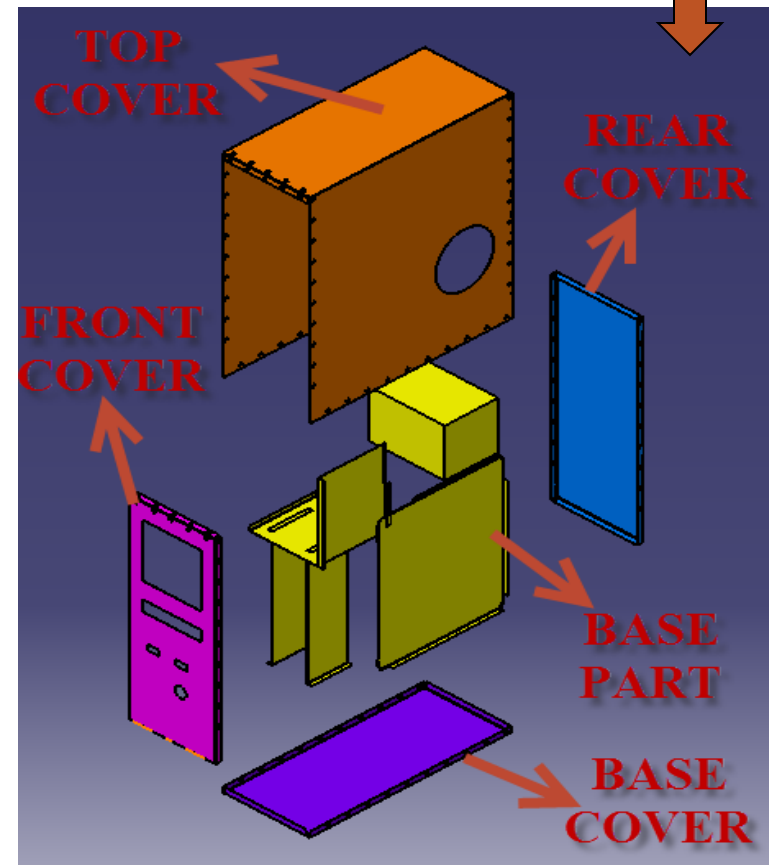

Differences Between Configurations

Configuration-1

- Requires 6 cover parts to enclose the inside base parts of a cabinet completely.
- The side cover is a movable part. By sliding this part, any other inside base parts can be accessed.

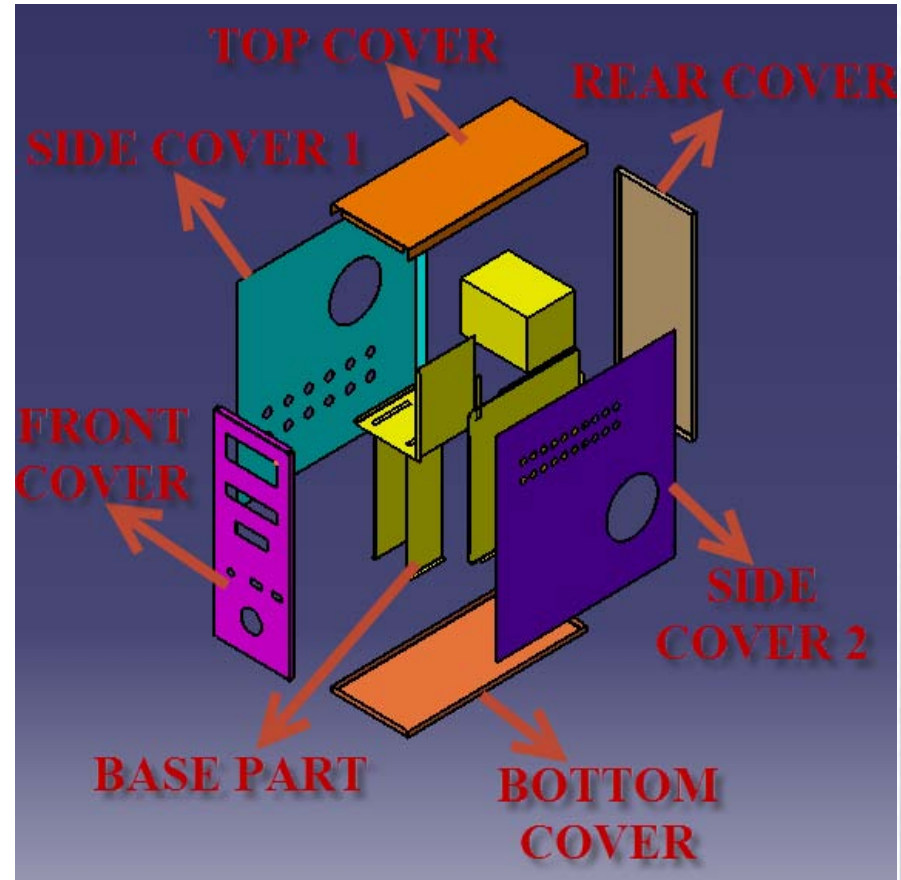

Differences Between Configurations

Configuration-2

- The top cover is lifted from above to access the inside parts.
- Requires only 4 cover parts to enclose the inside parts completely.

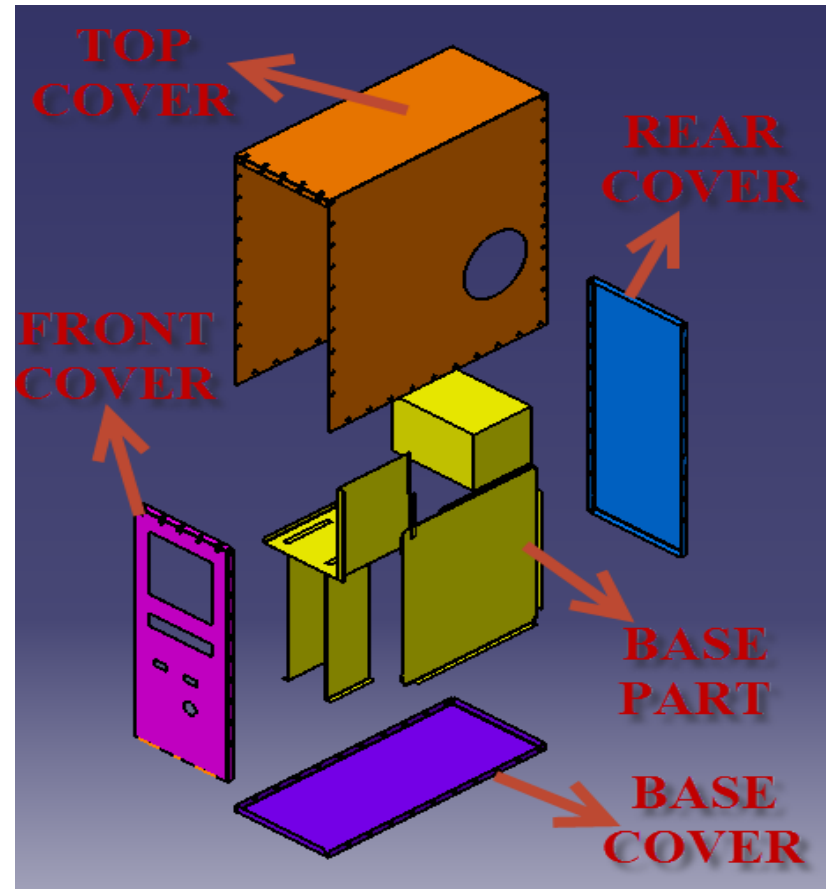

Final Outputs of Configurations 1 & 2

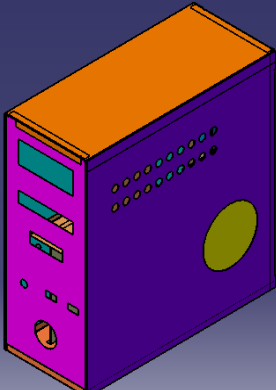
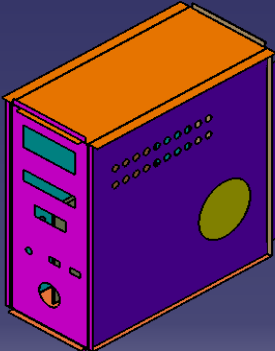
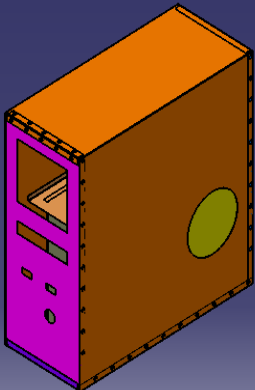
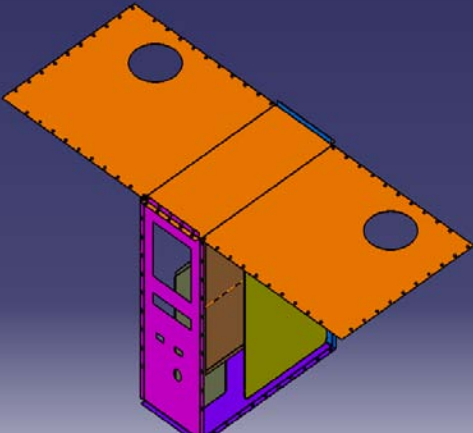
Tree-Structure	Final Model	Flat Pattern View
<ul style="list-style-type: none"> Parameters Relations Sheet Metal Parameters Inputs PartBody <ul style="list-style-type: none"> Base_Part Bottom_Cover Front_Cover Rear_Cover Top_Cover Side 1_Cover Side 2_Cover 		
Tree-Structure	Final Model	Flat Pattern View
<ul style="list-style-type: none"> Parameters Relations Sheet Metal Parameters Inputs PartBody <ul style="list-style-type: none"> Base_Part Bottom_Cover Front_Cover Rear_Cover Top_Cover 		

Second Application – Enclosure Design

- The second example is the enclosure design.
- Two enclosure configurations are as shown in following slides.
- They package various aerospace electronic PCBs boards into a compact space with user-defined mounting provisions.
- The approach used here is very similar to computer cabinet application.
 - A base part is generically constructed using the location of connectors, size, mounting holes and PCB Boards spatial requirements.
 - Mounting surfaces and guiding curves along the two sides and top portion of the base part are extracted.
 - A sheet metal Cover PC is written, which generates a design of a cover from seven inputs: 3 planes and 4 curves.
 - A design of the actual cover is obtained by instantiating this power-copy using the seven extracted features from the base part.

Configurations 1 & 2 Of Enclosure Design

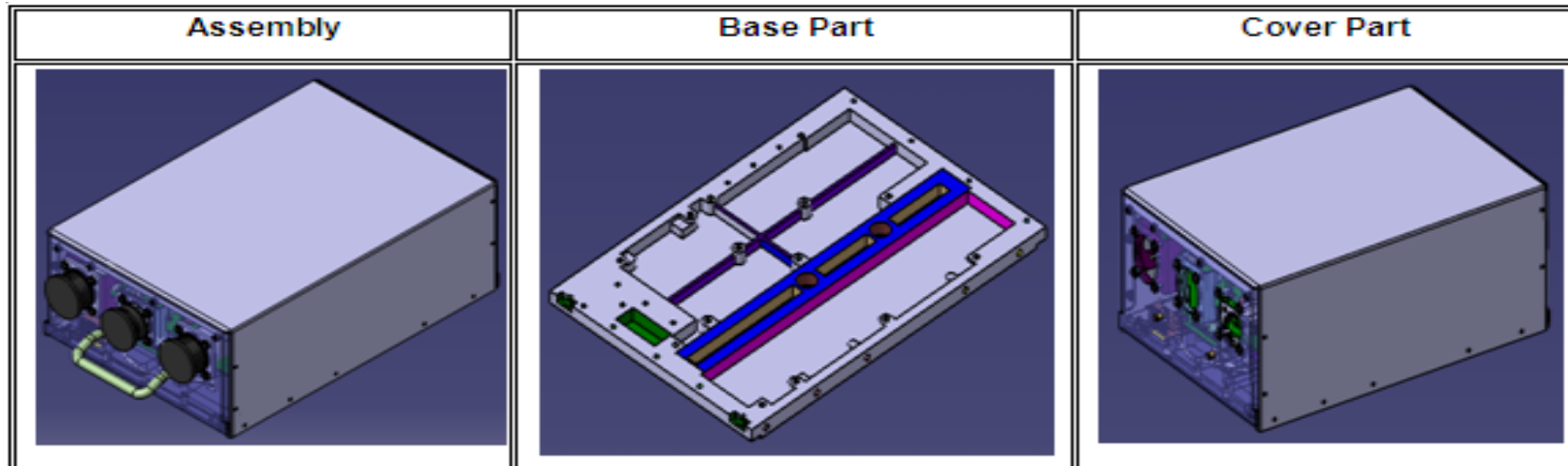
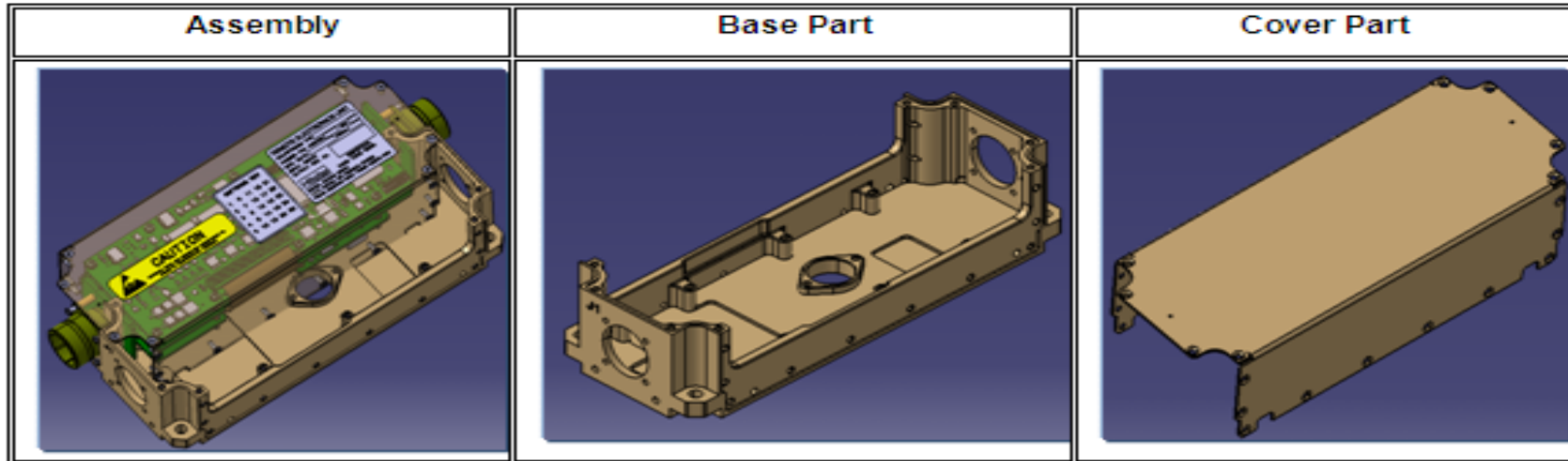

Advantages of sheet-metal power-copies over part design power-copies

- The morphability of sheet-metal power-copy cannot be achieved using part design workbench.
- Re-usability avoids creation of many PCs . One PC template can be used to achieve many topological variations by editing its parameters.
- The sheet-metal parameters such as bend radius, corner relief, flange lengths are all built-in as a part of sheet-metal design definitions.
- No additional work is required. Feature variations can be easily controlled through parameters as previously shown.
- Users can remove or add any of the features without changing the CATIA tree structure.
- The power-copy features can be repeated by simply checking the repeat button. This allows users to complete any numbers of instantiations with varying inputs. This reduces the design cycle time.
- PC-based processes give a consistent look and feel to the completed design.

Advantages shown via images

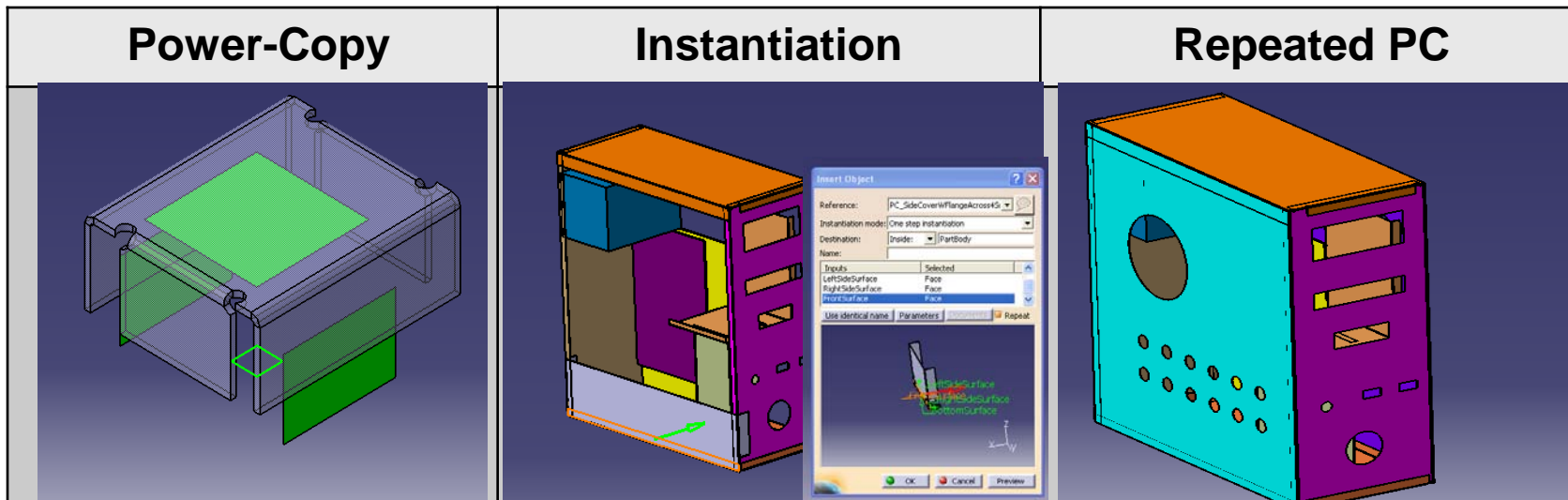
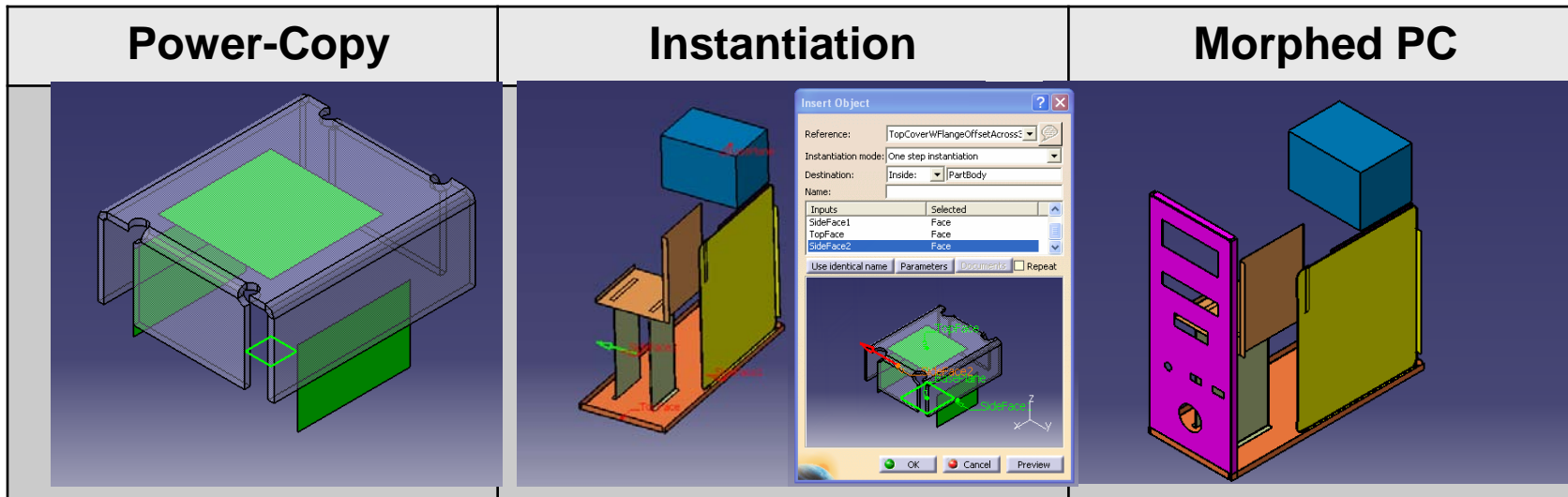

Advantages shown via images Contd..

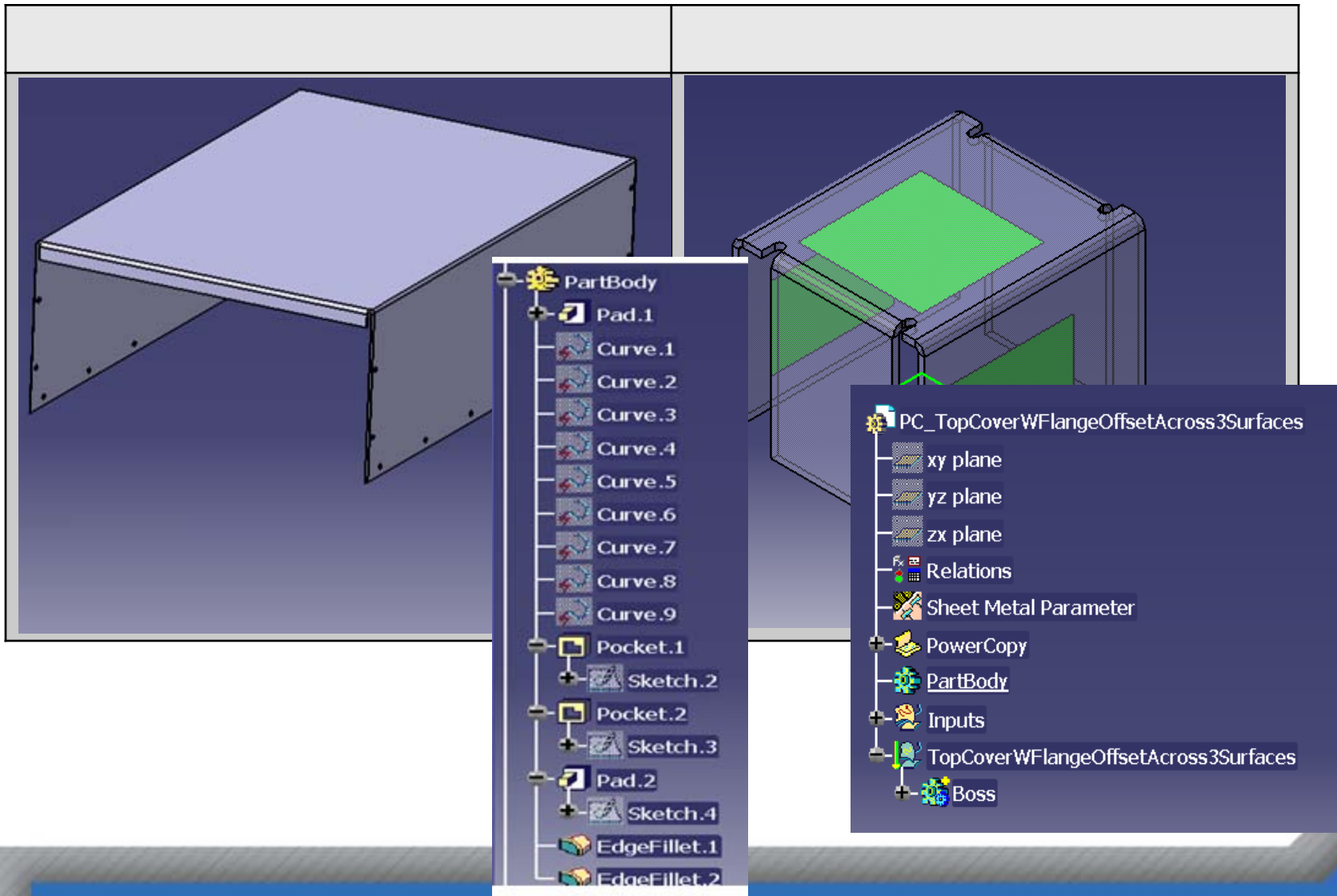

Concluding Remarks

- It is possible to create modular set of Sheet-metal power copies that are both re-usable and morphable.
- Topological variations of the geometry can be obtained by simply changing their parametric values.
- Sheet-metal features like bend radius, bend relief, flange length can be made associative to sheet-metal parameters in the specification tree.
- Instantiation of power-copies is easier and takes less time than to create sheet-metal parts manually.
- The user interface is very intuitive and requires less human interventions.
- PCs reduce design cycle time. Multiple configurations of parts can be obtained in less time.

Acknowledgement

Parker CSD Team

- ◆ Brian Prasad (Lead)
- ◆ Harrison Huynh
- ◆ Allyn Van Ry
- ◆ Kathleen Fay
- ◆ Steven Emter
- ◆ Lisa Luong

HCL Team

- ◆ Srinivasa Veerappa (Lead)
- ◆ Gautam Ashok
- ◆ Murari. L
- ◆ Shashikanth M.

Questions?

Brian Prasad

*Leader, Knowledge Engineering Team
Parker Aerospace, Control Systems Division
Irvine, California
bprasad@parker.com*

Srini Veerappa

*Technical Expert
HCL America Inc., Irvine, CA
Srinivasa.Veerappa@hcl.com*